

HUAWEI Band 4

User Guide

Issue 01
Date 2019-10-23



Copyright © Huawei Technologies Co., Ltd. 2019. All rights reserved.

No part of this document may be reproduced or transmitted in any form or by any means without prior written consent of Huawei Technologies Co., Ltd.

Trademarks and Permissions



HUAWEI and other Huawei trademarks are trademarks of Huawei Technologies Co., Ltd.

All other trademarks and trade names mentioned in this document are the property of their respective holders.

Notice

The purchased products, services and features are stipulated by the contract made between Huawei and the customer. All or part of the products, services and features described in this document may not be within the purchase scope or the usage scope. Unless otherwise specified in the contract, all statements, information, and recommendations in this document are provided "AS IS" without warranties, guarantees or representations of any kind, either express or implied.

The information in this document is subject to change without notice. Every effort has been made in the preparation of this document to ensure accuracy of the contents, but all statements, information, and recommendations in this document do not constitute a warranty of any kind, express or implied.

Huawei Technologies Co., Ltd.

Address: Huawei Industrial Base
Bantian, Longgang
Shenzhen 518129
People's Republic of China

Website: <https://www.huawei.com>

Email: support@huawei.com

Contents

1 Getting started.....	1
1.1 Wearing your band.....	1
1.2 Adjusting or replacing the strap.....	2
1.3 Pairing your band with your phone.....	3
1.4 Powering on/off and restarting the band.....	5
1.5 Charging your band.....	5
1.6 Icons.....	7
1.7 Controlling your band screen.....	11
1.8 Adjusting screen brightness.....	12
1.9 Setting the time zone and language.....	12
1.10 Viewing the Bluetooth name, MAC address, and Serial Number.....	13
1.11 Checking system information.....	13
1.12 Updating your band and the Huawei Health app.....	13
1.13 Restoring the band to factory settings.....	14
2 App management.....	15
2.1 Message reminders.....	15
2.2 Viewing messages.....	17
2.3 Deleting messages.....	17
2.4 Incoming calls.....	17
2.5 Remote photo shooting.....	18
2.6 Using Stopwatch.....	18
2.7 Setting a Timer.....	19
2.8 Setting an alarm.....	19
2.9 Syncing an alarm from your phone.....	20
2.10 Weather reports.....	20
2.11 Finding your phone using the band.....	21
2.12 Changing watch faces.....	21
3 Professional workouts.....	22
3.1 Starting a workout.....	22
3.2 Recording daily activity data.....	23
4 Health and fitness.....	24
4.1 Measuring heart rate.....	24

4.2 Sleep tracking.....	25
4.3 Activity reminder.....	26

1 Getting started

- 1.1 Wearing your band
- 1.2 Adjusting or replacing the strap
- 1.3 Pairing your band with your phone
- 1.4 Powering on/off and restarting the band
- 1.5 Charging your band
- 1.6 Icons
- 1.7 Controlling your band screen
- 1.8 Adjusting screen brightness
- 1.9 Setting the time zone and language
- 1.10 Viewing the Bluetooth name, MAC address, and Serial Number
- 1.11 Checking system information
- 1.12 Updating your band and the Huawei Health app
- 1.13 Restoring the band to factory settings

1.1 Wearing your band

To make sure that activity and sleep tracking and heart rate monitoring work properly, make sure you are wearing your band correctly as shown in the following figure.

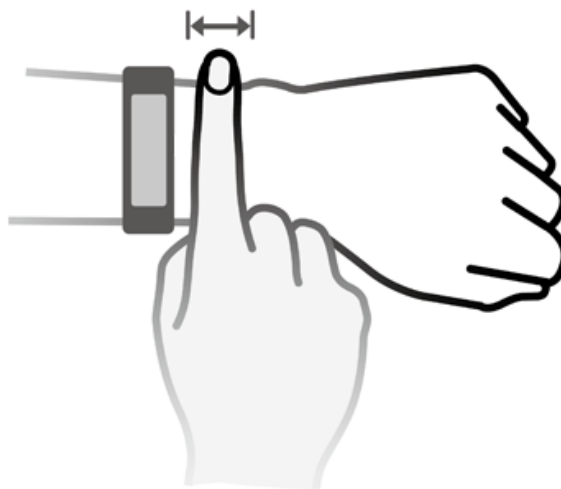

The band strap adopts a U-shaped buckle design so it won't fall out easily. To wear the band, insert one end of the strap through the U-shaped buckle and then fasten it. The end of the strap is intentionally bent so as to enhance wearability.

 **NOTE**

- Your band is made of materials that are safe to use. If you experience skin discomfort when wearing the band, stop using it and consult a doctor.
- Be sure to wear your band properly to maximize comfort.

1.2 Adjusting or replacing the strap

Adjustments: The strap has U-shaped buckles. Simply adjust which hole you use to tighten or loosen the strap.

Replacement:

- Removing the strap: Press and hold the quick release button to remove both parts of the strap.

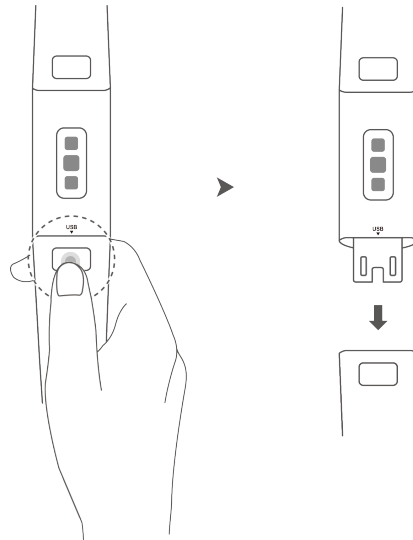

- Installing the strap: Clip in the strap from the correct ends and directions.

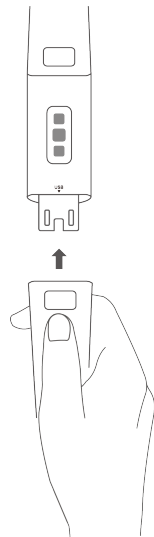

1.3 Pairing your band with your phone

When using your band for the first time, plug your band into a power source and it will automatically turn on. The band will enter Bluetooth pairing mode by default.

 **NOTE**

- Your band can only be paired with phones running Android 4.4 or later, or iOS 9.0 or later. Make sure that you have enabled Bluetooth on your phone before starting pairing.
- Once paired, the device's name will appear in the notification and the **Settings'** Bluetooth list. HWSynergy will appear under its name if it supports the feature. Your phone must be EMUI 8.0 or later to use it.

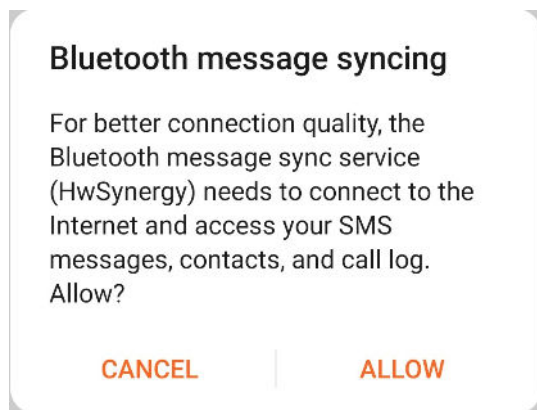

- **For Android users:**
 - a. Search for and install the latest version of the Huawei Health app in an app store on your phone. (For Huawei device users, search for and install the Huawei Health app through AppGallery.)
 - b. Open the Huawei Health app, go to **Devices > Add > Smart Band**, and select your band's name.
 - c. Touch **PAIR**, and the Huawei Health app will start searching for the band. Then select the correct device name from the list of available devices, and it will start pairing on its own.

 **NOTE**

When you turn on your band for the first time or pair it with your phone after a factory reset, you'll be prompted to select a language before pairing. After your band is paired with your phone, your band will adapt to your phone system language.

- d. Your band will vibrate when it receives a pairing request. Touch  to confirm pairing.

 **NOTE**

- Your band screen will display an icon when the pairing is complete. It will take about 2 seconds to sync important information from your phone (such as date and time).
- Otherwise, your band screen will display a different icon to inform you that the pairing failed then return to the startup screen 2 seconds later.

- **For iOS users:**
 - a. Search for and install the Huawei Health app in the App Store on your phone.
 - b. Open the Huawei Health app, touch **Devices**, then go to **Add > Smart Band**, and touch your band's name.
 - c. The Huawei Health app will search for the band automatically. Select the correct device from the list of Bluetooth devices available, and the pairing will start automatically.

 **NOTE**

When you turn on your band for the first time or pair it after a factory reset, you'll be prompted to select a language before pairing. After your band is paired with your phone, your band will display the language that set on your phone.

- d. Your band will vibrate when it receives a pairing request. Touch  to confirm pairing.
- e. Once your phone displays the Bluetooth pairing request, touch **PAIR** to begin pairing.

1.4 Powering on/off and restarting the band

Powering on your band

Your band will automatically power on when you charge it.

Powering off your band

Swipe on the screen until you find **More**, then go to **System > Power off**. After you have read the prompt, then touch .

 **NOTE**

To power your band on after it has turned off, just plug it into a power source, your band will automatically power on.

Restarting your band

Swipe on the screen until you find **More**, then go to **System > Restart**.

1.5 Charging your band

Press and hold the quick release button on the longer strap to detach the band body from the strap. Plug the band body directly into a power source with a USB port.

Check the charging end of the band body, and determine which side has metal strips. Carefully insert the band body into a USB charging port so that the metal contacts are facing the middle of the USB port (rather than up against the walls of the port). The band body will vibrate to indicate that it is being charged properly. If it doesn't vibrate, maneuver the band body into a different position, and try again.

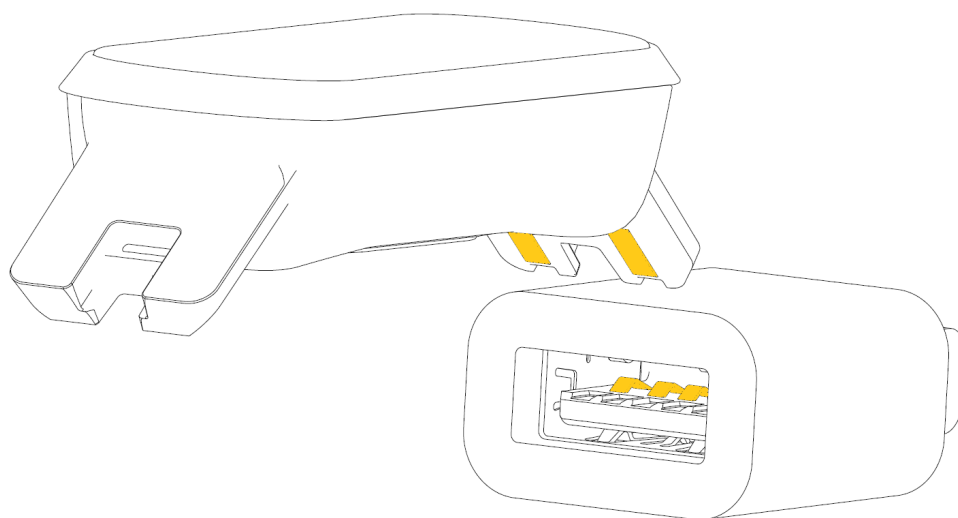
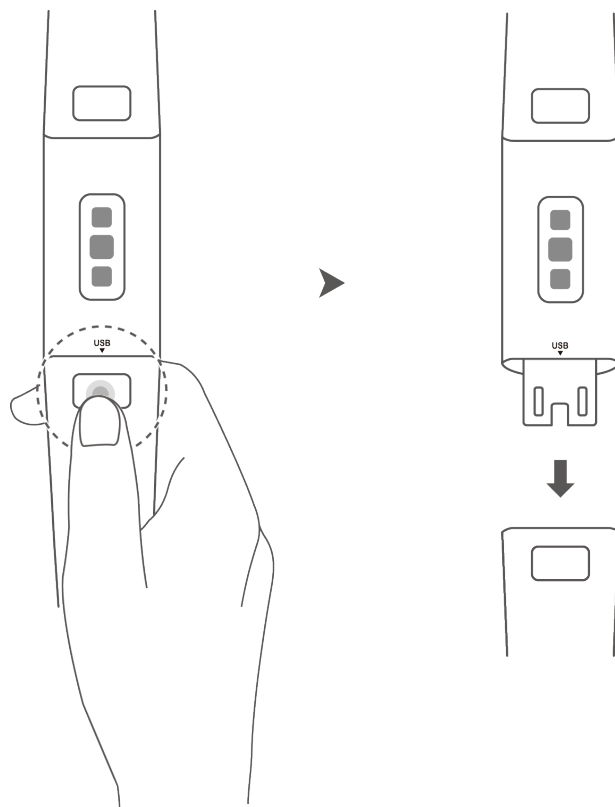

NOTE

- Before charging, make sure that the charging port and metal parts are clean and dry to prevent short circuiting or any other risks.
- If the band screen flickers or goes black, connect it to a power source to restart the band.
- Use a Huawei charger with a rated output voltage of 5 V and a rated output current of 1 A or above or a computer to charge your band. Using a non-Huawei charger may be slower and could cause your band to heat up. Exercise caution when using a non-Huawei charger. Please purchase an original Huawei charger from an official Huawei retail channel.

Charging time: It takes about 100 minutes to fully charge your band with a 25°C room temperature. Once the battery icon is full, your band is fully charged.

 **NOTE**

To ensure battery safety, the charging current will be decreased substantially when the ambient temperature is too low. This means it will need longer to charge. It is recommended that you charge your band in an environment with an ambient temperature higher than 20°C.

Checking the battery level:

- If the screen is on, just tap the screen to check the battery.
- Alternatively go to **More > Battery** to check it.
- You can also open the Huawei Health app on the connected phone and touch **Devices** to see the battery level.

 **NOTE**

Battery level is displayed as a whole number percentage.

Low battery alert

If the battery level is lower than 10%, your band will vibrate, and the band screen will display



to remind you to charge your band as soon as possible.

1.6 Icons



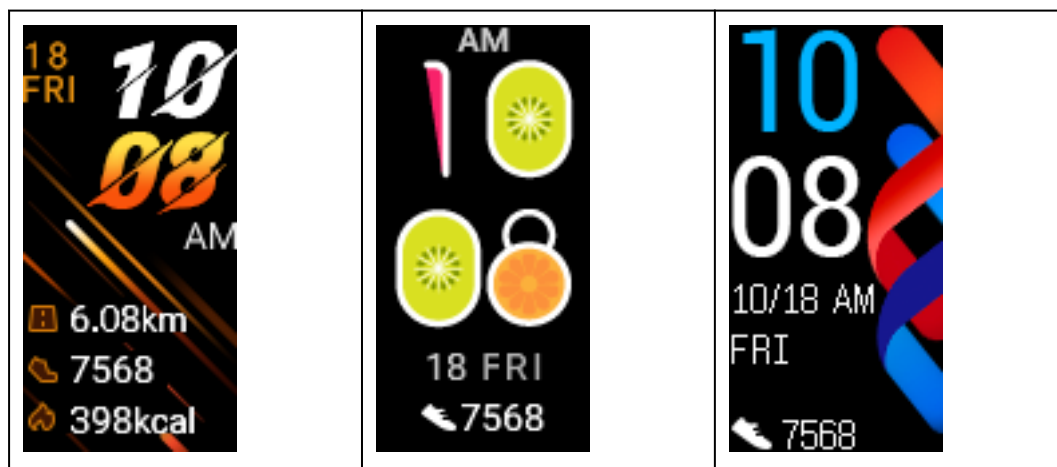

Preinstalled watch faces:

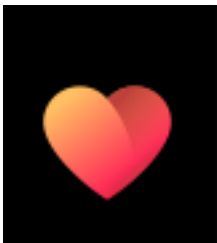

 **NOTE**

Actual appearances may vary. Watch faces are subject to change, and the ones above are for reference only.

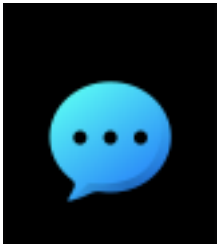



Level 1 menu:

<p>Activity record</p> 	<p>Heart rate</p> 	<p>Sleep</p> 
<p>Workout</p> 	<p>Messages</p> 	<p>More</p> 

 **NOTE**

The percentage displayed under **Daily tracking** indicates your progress towards your goal.

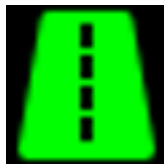
Activity records:



<p>Step count</p> 	<p>Calories burned</p> 	<p>Distance</p> 
<p>Moderate to high intensity activity</p> 	<p>Times standing</p> 	<p>-</p>

Workout modes:

 **NOTE**

Outdoor cycle requires GPS and EMUI 5.0 or later (or iOS 9.0 or later). The Outdoor Cycle icon will be hidden on your band if your phone does not meet these requirements.



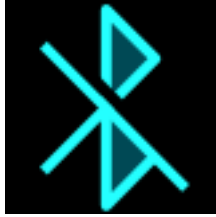
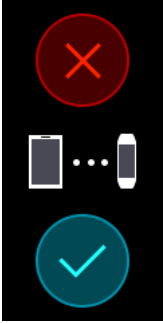
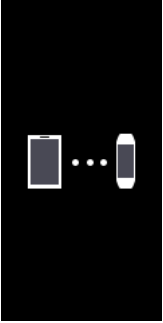
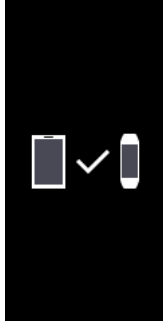

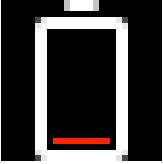
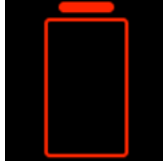

Connection and pairing:



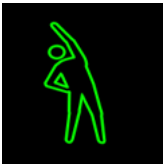



<p>Bluetooth not connected</p> 	<p>Bluetooth connected</p> 	<p>Connect with Bluetooth</p> 
<p>First-time pairing request</p> 	<p>Pairing</p> 	<p>Paired</p> 

Battery:

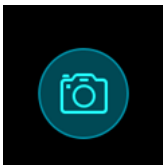



















<p>Charging</p> 	<p>Low battery</p> 	<p>Critically low battery</p> 
---	--	---

Others:

<p>Activity reminder</p> 	<p>Updating</p> 	<p>Failed to update</p> 
<p>Decompressing</p> 	<p>Alarm</p> 	<p>Find phone</p> 

Unread messages 	Take photos 	Confirm 
Cancel 	End 	Pause 
Start 	-	-

Weather:

Sunny 	Cloudy 	Overcast 	Showers 
Thunder storms 	Hail storms 	Light rain 	Rain 
Severe rain storms 	Snow flurries 	Light snow 	Snow 
Heavy snow 	Snow storms 	Dust storms 	Dust 
Sand 	Sand storms 	Smog 	No data 

Fog 	Freezing rain 	Heavy rain 	Heavy rain storms 
--	--	--	--

1.7 Controlling your band screen

Your band has a full screen touchscreen and can detect up, down, and right swipes, as well as when you touch and hold the screen. It works with the Home key to make using your band even easier.

Steps	Function	Notes
Touch the Home key when the screen is on	Return to the home screen	There are certain cases such as during workouts or calls where this won't work.
Touch the Home key when the screen is off	Wake the band	Touching the Home key when the screen has been off for less than 10 seconds will take you back to the last screen, if it has been more than 10 seconds, this will bring you to the home screen.
Swipe right from the home screen	Check messages on your band	You will only see messages if you have some saved on your band. This screen is for deleting messages.
Swipe right on screens other than the home screen	Return to the previous screen	-
Swipe up or down on the level 1 screen	Browse through features	-
Touch the screen	Select and confirm	-
Touch and hold the home screen	Change watch faces	-

Waking the screen

To wake the screen, touch the Home key, raise your wrist, or rotate your wrist towards yourself. The screen will sleep again after 5 seconds if you don't do anything.

 **NOTE**

- You can enable **Raise wrist to wake screen** in the Huawei Health app.
- The maximum length of time that the screen of your band can stay on is 5 minutes. To extend the length of time that the screen stays on time, do the following: go to **More > Screen on** and then enable **Screen will sleep after 5 min**. Now the screen will automatically turn off after five minutes these changes are temporary. You will need to extend the time again after you wake the screen.

Switching between screens

To switch between screens when the screen is on, rotate your wrist or swipe in any direction on the screen.

 **NOTE**

You can enable **Rotate to switch screen** in the Huawei Health app.

Turning off the screen

- Lower your wrist or rotate it away from your body.
- The screen will automatically turn off if the band is idle for 5 seconds.

1.8 Adjusting screen brightness

Find the **More** screen, then go to **Brightness > Brightness** and adjust the screen's brightness.

 **NOTE**

There are five brightness levels for the band. Screen brightness is set to level 3 by default. Level 5 is the brightest, while level 1 is the dimmest.

You can enable **Lower brightness at night** to automatically set the band to dim at night from 20:00 to 06:00 the next day.

1.9 Setting the time zone and language

After the band syncs with your phone, the time zone and language settings on your phone will automatically sync to your band.

If you change the language, region, time, or time format on your phone, the changes will automatically sync to the band, as long as the band is connected to your phone.

 **NOTE**

1. If the language and region information on your phone are supported on the band, the language on your band will be consistent with that displayed on your phone.
2. If the language on your phone is supported on the band while the region is not, the band will display the same language as that displayed on your phone. For example, if the language displayed on your phone is Brazilian Portuguese, the band will display European Portuguese instead.
3. If the language on your phone is not supported on the band, the band will display English by default.
4. If the system language on your phone is traditional Chinese, the band will display Simplified Chinese.

1.10 Viewing the Bluetooth name, MAC address, and Serial Number

Viewing the Bluetooth name:

Method 1: Connect the band to your phone using the Huawei Health app. The device name displayed in the app is the name that will be displayed when using Bluetooth.

Method 2: On your band, go to **More > System > About**, the device name displayed on the band screen, this is the name that you will see when using Bluetooth.

Viewing the MAC address:

Method 1: Go to **More > System > About** on your band. The MAC address will be displayed as 12 alphanumeric characters next to **MAC:**.

Method 2: Check the back of your band for the MAC address. The 12 alphanumeric characters are your band's MAC address.

Method 3: If your band is connected to a phone through the Huawei Health app, open the Huawei Health app, touch **Devices**, and then touch your device's name. The information next to **Restore factory settings** is the MAC address.

Viewing the Serial Number:

On your band, go to **More > System > About**, and swipe up from the bottom of the screen. You'll see the band's Serial Number, which includes 16 alphanumeric characters, they are next to **SN:**.

1.11 Checking system information

Method 1: Check on your band.

To check your band's version, go to **More > System**, and touch **About**.

Method 2: Check through the Huawei Health app.

If your band is connected to the Huawei Health app, open the app and touch **Devices** and your device. Then touch **Firmware update** to check the band's version.

1.12 Updating your band and the Huawei Health app

To continue improving user experience, new updates are released from time to time. When a new update is available, perform the following steps to update your band and the Huawei Health app.

Updating your band

Method 1: Connect your band to the phone using the Huawei Health app. Open the Huawei Health app, touch **Devices** and then touch your device name. Touch **Firmware update** and follow the onscreen instructions to update your band.

Method 2:

- **For Android users:** Open the Huawei Health app. Touch **Devices**, then your device name, enable **Auto-update device over Wi-Fi**. If an update is available, a notification will pop up on your band. Follow the onscreen instructions to update your band.
- **For iOS users:** Open the Huawei Health app and touch the profile picture in the upper left corner. Touch **Settings** and enable **Auto-update device over Wi-Fi**. If an update is available, a notification will pop up on your band. Follow the onscreen instructions to update your band.

Updating the Huawei Health app

For Android users: Open the Huawei Health app. Touch **Me** then **Check for updates**.

For iOS users: Update the Huawei Health app through App Store.

NOTE

During an update, your band will automatically disconnect from Bluetooth, but will reconnect once the update is complete.

1.13 Restoring the band to factory settings

Method 1: Using the band

Swipe on the screen until you find **More**, then go to **System > Reset**, and touch . Resetting the band will clear all the data from the band. Please use caution when resetting your band.

Method 2: Using the Huawei Health app

Open the Huawei Health app, touch **Devices** and then touch your device. Touch **Restore factory settings**.

2 App management

- 2.1 Message reminders
- 2.2 Viewing messages
- 2.3 Deleting messages
- 2.4 Incoming calls
- 2.5 Remote photo shooting
- 2.6 Using Stopwatch
- 2.7 Setting a Timer
- 2.8 Setting an alarm
- 2.9 Syncing an alarm from your phone
- 2.10 Weather reports
- 2.11 Finding your phone using the band
- 2.12 Changing watch faces

2.1 Message reminders

Enable notifications

Once enabled, the band can sync messages displayed in the phone's status bar to your band.

Your band can display notifications from the following apps: SMS, Email, Calendar, and various social media platforms.

1. Update your band and the Huawei Health app to the latest version.
2. Set the Huawei Health app as a protected app to ensure that the app runs in the background.
3. **For Android users:** Open the Huawei Health app, touch **Devices**, and then touch your device. Touch **Notifications** and enable **Notifications**. Turn on the switch for apps for which you want to receive notifications.

At the same time, enable notifications in your phone Settings to receive notifications from apps. For example, users with phones that run EMUI 8.1.0 should perform the

following: Go to **Settings > Apps & notifications > Notifications management**, touch the app for which you want to receive notifications, and enable **Allow notifications** and **Display in the status bar**.

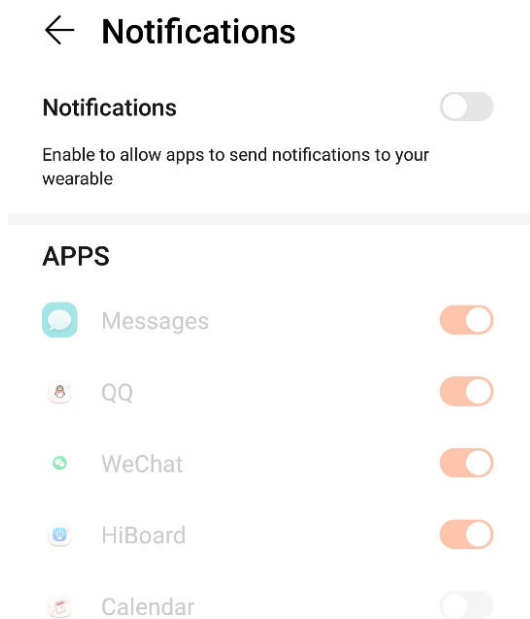

4. **For iOS users:** Open the Huawei Health app, touch **Devices** then your device name. Enable **Notifications**. Turn on the switch for apps for which you want to receive notifications.

At the same time, enable notifications in your phone Settings for apps for which you want to receive notifications.

NOTE

- Your band will not notify you of new messages during a workout or in Ultra-low battery mode. After you end the workout or disable Ultra-low battery mode, swipe in any direction on your band's home screen (except to the left) to view new messages.
- If you enable **Do not disturb when not wearing**, you will receive new messages only when wearing the band.
- If you are using a chat app, messages will not be pushed to your band. For example, messages on a chat screen in WhatsApp will not be pushed to your band.
- Your band supports Bluetooth disconnection reminders. Enable this feature on the device details screen in the Huawei Health app.
After the Bluetooth disconnection reminder feature is enabled, your band will vibrate when the Bluetooth connection is disconnected. Ensure that your band is properly connected to your phone.

Disable notifications

- To disable notifications in the Huawei Health app:
 - **For Android users:** Open the Huawei Health app, touch **Devices**, and then touch your device. Touch **Notifications** and then disable **Notifications**.
 - **For iOS users:** Open the Huawei Health app, touch **Devices**, and then touch your device. Disable **Notifications**.
- You are able to enable **Do not disturb** on the device details screen in the Huawei Health app. Once this mode is enabled, your band will not vibrate or turn on the screen to

inform you of any incoming messages during a set period. The Raise wrist to wake screen will also be unavailable when **Do not disturb** is enabled. To avoid missing important messages, it is recommended that you do not enable Do not disturb mode.

NOTE

Your band will only receive and will not push any notifications when it is in Do not disturb mode or Sleep mode. Swipe in any direction on your band's home screen (except to the left) to view new messages.

2.2 Viewing messages

You are able to receive alerts on your band when new app notifications are displayed on your phone status bar. Turn on your band screen in order to view messages. The incoming messages will be displayed on the band screen directly when your band screen is on.

An unread message reminder icon will be displayed in the top-right corner of the band screen or on the screen after you touch the home screen. Swipe right on the home screen, or swipe up or down on your band's app list to enter the message screen to view unread messages.

NOTE

- You can directly view the content of a single message when it is the only one displayed. Otherwise, touch to select the message you want to read.
- You can swipe right on the band's unread message details screen to exit viewing one message, and delete it from the unread message center.
- A maximum of 10 unread messages can be saved on your band. If there are more than 10 unread messages, previous messages will be overwritten. A single message can be displayed on two screens at most. Swipe on the screen to view the message. You can view the remaining content on your phone.
- Messages that have been marked as read can no longer be viewed on the band. To view message history, please check your phone.
- You are unable to swipe right on the band home screen when there are no cached messages as the unread message center is automatically hidden.

2.3 Deleting messages

Swipe on the band's home screen (except to the left) to view unread messages when there are new incoming messages.

Delete one message: Swipe right on the message content display screen.

Delete all messages: Touch **Clear All** at the bottom of the message list to delete all unread messages.

Android users: Messages from third-party social media apps and text messages will be deleted automatically once read or deleted on your phone.

iOS users: Messages will be deleted automatically once read or deleted on your phone.

2.4 Incoming calls

Your band will vibrate and turn on its screen to notify you of an incoming call. A contact name and number will also be displayed. Touch the reject call icon or swipe up from bottom on your band to reject a call, or touch the band screen or the Home key to ignore/mute a call.

If you do not perform any operation during an incoming call, your band will display a message to notify you of the missed call. Swipe right on the home screen to clear the message.

 **NOTE**

- The band screen will remain on when notifying you of an incoming call.
- Your band can mark an unknown number. This feature is available only when the band is paired with a phone running EMUI 4.0 or later.
- Your band will vibrate and turn on its screen to notify you of any incoming calls during a workout.
- When pairing your band with an Android phone, touch the band screen or the Home key to return to the home screen and ignore incoming calls. Muting calls is only supported on iOS. To use this feature, touch your band screen or the Home key. Your band will display a muting screen and then the home screen after two seconds. Proceed to mute the call.

2.5 Remote photo shooting

 **NOTE**

This feature is only available on Huawei phones running EMUI 8.1 or later.

1. After connecting your band to your phone, open Camera on your phone, and your band screen will turn on and display the camera icon shown below.

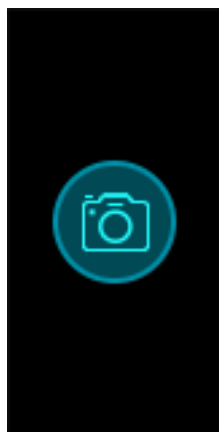

2. Touch the camera icon on the band screen to take photos on your phone. The band will return to the camera shutter screen two seconds after taking a photo.

 **NOTE**

1. The band screen will automatically turn off if no operation is performed on the camera shutter screen for five seconds.
2. From the camera shutter screen, touch the Home key to return to the home screen, or swipe right on the band screen to go back to the previous screen.
3. To exit the camera shutter screen on your band, close the Camera app on your phone or disconnect your phone from the band.



2.6 Using Stopwatch

To use the Stopwatch function on your band, do the following steps:

1. Touch **More** and then select **Stopwatch**.





2. Touch  to start timing. The stopwatch can count up to "59:59.9". Once it hits that number it will stop on its own.

3. While Stopwatch is running, you are able to:

- Touch  to stop timing.
- Touch  to resume timing.
- Touch  to end timing and reset the stopwatch to "00:00.0".
- Swipe right to return to **More** screen without stopping timing.

2.7 Setting a Timer

To use the Timer on your band, perform the following steps:

1. To use this function, go to **More > Timer** on your band screen.
2. Setting the Timer
 - When using the Timer function for the first time, access the Timer settings screen of your band, and set the hours, minutes, and seconds. The value range for hours is 0 - 11, while that of minutes and seconds is 0 - 59.
 - If you have used the Timer function before, open the Timer screen you accessed last time and touch , and set the hours, minutes, and seconds.
3. Touch  to start the Timer.
4. Touch  to pause the timing, and touch  to end it.
5. Your band will vibrate and its screen will switch on to notify you when the set time has been reached. Swipe right on the screen or touch  to turn off the Timer. Perform no operations and Timer will automatically close after 1 minute.

NOTE

When Timer is enabled, the on-going timing screen will display when you return to it again from the home screen.

2.8 Setting an alarm

You can use the Huawei Health app to set a Smart alarm or an Event alarm for a connected band.

- A Smart alarm, has two conditions to go off, it needs to be around when the time it was set for and you need to be in light sleep. This type of alarm helps your body gradually adjust to waking up and helps you wake up feeling more refreshed.

NOTE

The Smart alarm feature is only available when **HUAWEI TruSleep™** is not enabled.

- The Event alarm will always go off at the specified time. If you set a tag for the Event alarm, the band will display the tag. Otherwise, only the time will be displayed.

For Android users:

1. Open the Huawei Health app, touch **Devices**, touch your device, and then go to **Alarm > SMART ALARM** or **Alarm > EVENT ALARMS**.
2. Set the alarm time, repeat cycle, and the snooze cycle under **Smart wakeup**.
3. Touch  in the top-right corner to save your settings.
4. Swipe down on the home screen of the Huawei Health app to make sure the alarm settings are synced to your band.

For iOS users:

1. Open the Huawei Health app and touch **Devices**.
2. Touch the band's Bluetooth name from the device list.
3. Go to **Alarm > SMART ALARM** or **Alarm > EVENT ALARMS**.
4. Set the alarm time, repeat cycle, and the snooze cycle under **Smart wakeup**.
5. Touch **Save**.
6. Swipe down on the home screen of the Huawei Health app to make sure the alarm settings are synced to your band.

NOTE

- When the band rings, touch the Home key on your band to snooze it or hold it to turn off the alarm. Hitting snooze means the alarm will go off in another 10 minutes.
- If you don't do anything after the alarm goes off, it will automatically turn to snooze, after this happens 3 times the alarm will automatically turn off.

2.9 Syncing an alarm from your phone

You can sync alarms from your phone to your band (phone must be EMUI 8.1 or above). When an alarm goes off on your phone, you can even dismiss or snooze it with your band.

NOTE

- Ensure that the band is connected to the phone through the Huawei Health app.
- If you are unable to sync alarms from your phone, disconnect the two before reconnecting them and trying again.

2.10 Weather reports

Make sure you are using a band theme that displays the weather from the home screen. Once this is set up, you will be able to see the latest weather reports on your band:

1. Enable **Weather reports** on the device details screen in the Huawei Health app.
2. Make sure that GPS and Location enabled in the notification panel and that Huawei Health has been granted the Location permission.

For users having phones running a version earlier than EMUI 9.0, Select **Use GPS, WLAN, and mobile networks**, or **Use WLAN and mobile networks** for the positioning mode instead of **Use GPS only**.

 **NOTE**

- If it has been set up successfully, you will see the weather and temperature displayed on your band. If it is unable to sync, they will not appear.
- The weather information displayed on your band comes from the Huawei Health app, and may differ slightly from what's displayed on your phone since the information is from different service providers.
- You can switch between Celsius °C and Fahrenheit °F under **Weather reports** in the Huawei Health app.

2.11 Finding your phone using the band

Access the **More** screen, and touch **Find Phone**. An animation will display on the screen. If your phone is within the Bluetooth range, it will play a ringtone (even in Silent mode), notifying you of its whereabouts.

 **NOTE**

- To use this feature, ensure that the band is connected to your phone, and the Huawei Health app is running in the background or foreground.
- The Find phone feature works for 15 seconds. If the phone does not respond after 30 seconds, the band turns off its screen.

2.12 Changing watch faces

Your band comes with multiple watch faces for you to switch between. You can select the watch face that is most suitable for you. To change the watch face, perform the following:

- **Method 1:** Press and hold the home screen until your band vibrates and swipe through the previews. Touch a watch face to apply it.
- **Method 2:** Go to **More > Faces** and swipe through the previews. Touch a watch face to apply it.
- **Method 3:** Open the Huawei Health app, go to **Watch faces > More**, and touch **INSTALL** under your preferred watch face. Your watch face will automatically switch to the chosen one once it is installed. Alternatively, touch an installed watch face and touch **SET AS DEFAULT** to set the current watch face as your desired one.

 **NOTE**

- The Watch faces screen is not available on iOS phones. To download new watch faces, you are advised to temporarily pair your band with an Android phone. When the downloaded watch faces are synced to your watch, pair the watch back with your iOS phone.
- The watch face feature is available only in certain countries and regions. For more information, contact your local Huawei hotline.

Deleting a watch face:

You can only remove watch faces downloaded in the Huawei Health app. To do this,

touch the installed watch face then touch  in the top-right corner.

3 Professional workouts

3.1 Starting a workout

3.2 Recording daily activity data

3.1 Starting a workout

1. Swipe up or down on the band's home screen to find the **Workout** screen.
2. Swipe up or down on the screen to select a workout type. The following workout modes are supported on the band, **Outdoor run**, **Indoor run**, **Outdoor walk**, **Indoor walk**, **Outdoor cycle**, **Indoor cycle**, **Elliptical**, **Rower**, and **Other**.

NOTE

Outdoor cycle is only supported on phones with GPS functions (phones running EMUI 5.0 or later, or iOS 9.0 or later). The Outdoor Cycle icon will be hidden on your band if your phone does not meet these requirements.

3. You can set various workout goals, such as distance, duration, or calories burned, as well as a notification for customized intervals. After setting your goals, touch the icon at the bottom of the screen, and your band will start recording your workout.

NOTE

If you set up interval notifications, your band will wake up and vibrate at each interval.

- **Outdoor Run/Outdoor Walk/Indoor Run/Indoor Walk**: The interval for notifications is set to 1 km by default. You can customize the distance or switch to time based intervals in **Notify me**, or you disable them by going to **Notify me** and selecting **None**.
 - **Outdoor cycle**: The notification interval is set to 3 km by default. You can customize the distance or switch to time based intervals in **Notify me**, or you disable them by going to **Notify me** and selecting **None**.
 - **Other/Indoor cycle/Elliptical/Rower**: The notification interval is set to 10 minutes by default. You can customize the time by in **Notify me**, or you can disable them by going to **Notify me** and selecting **None**.
4. To view fitness data on your band during a workout when the screen is on, swipe up or down on the screen. To pause the workout, touch and hold the Home key for 2 seconds, then touch the corresponding key in the pop-out screen to continue or end the workout.

- Touch  to continue the workout.

- Touch  to end the workout and view your fitness data.

NOTE

- If the workout distance is less than 100 meters, it will not be recorded.
- The workout will not be recorded if it lasts for less than 1 minute when you are using **Outdoor cycle**, **Indoor cycle**, **Other**, **Elliptical**, or **Rower** mode.
- Make sure to touch the end icon after you're finished with a workout, to prolong battery life.
- During a workout, your band will vibrate and the screen will wake up if there is an incoming call. When there is a new message, it will be saved in the background. You can swipe right on the home screen to view new messages after your workout has ended.

3.2 Recording daily activity data

Wear the band properly and your band will record your activity data automatically, including your step count, workout distance, and calories burnt.

Perform either of the following methods to view your daily activity data:

Method 1: View your daily activity data on your band.

Swipe on the band screen and switch to the **Activity** screen. Swipe up and down on the screen to view your step count, calories burnt, exercise distances, duration of moderate to high intensity activities, and stand up times.

Method 2: View your daily activity data through the Huawei Health app.

View your detailed activity data on the home screen in the Huawei Health app.

NOTE

- To view your daily activity data in the Huawei Health app, ensure that your band is connected to the phone using the Huawei Health app.
- Your fitness data resets at 24:00 every night.

4 Health and fitness

[4.1 Measuring heart rate](#)

[4.2 Sleep tracking](#)

[4.3 Activity reminder](#)

4.1 Measuring heart rate

Measuring your heart rate manually

1. Keep your arm still and make sure your band is on correctly.
2. Swipe up or down on the home screen until you find **Heart rate**.
3. Tap it to start measuring your heart rate, and check your current heart rate.
4. Each measurement takes around 45 seconds, and the displayed heart rate is updated every 3 seconds.
5. During the measuring, you can press the Home key or swipe right on the screen to stop it from measuring.

An error message will pop up when you do not wear your band or wear it incorrectly.

NOTE

- To ensure the accuracy of heart rate measurements, wear the band properly and make sure the strap is fastened securely. Check that the band body is in direct contact with your skin.
- Stay as still as possible during the measurement.
- The heart rate data from manual measurements will not be synced to the Huawei Health app.
- The measurement will be interrupted if you swipe right on the band screen, receive an incoming call, or an alarm goes off.

Heart rate measurement during a workout

Your band displays your real-time heart rate during a workout.

After you start a workout, swipe on the band screen to check your heart rate and heart rate zone. The heart rate displayed is updated every 5 seconds.

You can set an upper limit for your heart rate and target zone on your band for individual workout modes. During the workout, if your heart rate exceeds the value that you set in the

Huawei Health app ("220 - your age" by default), your band will vibrate to notify you. Touch the Home key or swipe right on the screen to dismiss the alert.

After completing your workout, you can check your average heart rate, maximum heart rate, and heart rate zone from the workout on the results screen.

You can view graphs that show your heart rate throughout the workout, maximum heart rate, and average heart rate for each workout, on the workout record screen in the Huawei Health app.

NOTE

- If you remove the band from your wrist during the workout, it will not display your heart rate for that period of time. However, the band will continue to check for your heart rate. It will resume recording your heart rate when you put the band back on.
- If your band is connected to your phone, it will start measuring your heart rate in real time when you start a workout in the Huawei Health app.

Continuous heart rate monitoring

When you have connected your band to your phone using the Huawei Health app, you can enable **Continuous heart rate monitoring** in the app. This feature is disabled by default.

Measurement Frequency

1. Resting heart rate will be measured every 10 minutes when it detects that you aren't really moving (such as sitting).
2. Heart rate will be measured every 10 minutes during moderate-intensity activities (such as when you are walking).
3. Heart rate will be measured every second during high-intensity activities (such as when you are running), it will take about 6 to 10 seconds to measure and display the first heart rate value, though this initial delay varies between individuals.

Resting heart rate measurement

Resting heart rate, is a general indicator of cardiac health, and refers to a heart rate measured in a quiet, static, non-sleeping state.

To have your band check your resting heart rate regularly, enable **Continuous heart rate monitoring** in the Huawei Health app.

NOTE

- If you disable **Continuous heart rate monitoring** the heart rate data in the app will not be able to be updated.
- The best time to measure your resting heart rate is immediately after you wake up in the morning. The device is unable to detect the exact optimal time to check your resting heart rate, therefore it may not be displayed at all times in the app, and it may be slightly off from the actual value.

4.2 Sleep tracking

Your band collects sleep data and identifies your sleep status when you wear it while sleeping. It can automatically detect when you fall asleep and wake up and whether you are in a light or deep sleep. You can sync and view your sleep data in detail in the Huawei Health app.

You can enable **HUAWEI TruSleep™** in the Huawei Health app.

The band adopts HUAWEI TruSleep™ sleep tracking technology to accurately detect whether you are in a deep sleep, light sleep, REM sleep (rapid eye movement), or awake, and provide you with sleep quality assessments and suggestions for improving the quality of your sleep.

 **NOTE**

Enabling TruSleep may slightly reduce your band's battery life.

4.3 Activity reminder

When **Activity reminder** is enabled, your band will monitor your activity throughout the day in increments (set to 1 hour by default). Your band will vibrate and turn on its screen to remind you to make sure you have a good balance of activity and rest throughout the day.

Disable **Activity reminder** in the Huawei Health app if you find the reminders distracting.

 **NOTE**

- Your band will not vibrate to remind you to move around if you have enabled **Do not disturb** for your band in the Huawei Health app.
- Your band will not vibrate when it detects that you are asleep.
- Your band will only send reminders from 8:00 to 12:00 and from 14:00 to 20:00.